

Hand Dryers SLO 01L, SLO 01S



SLO 01L



SLO 01S

Characteristics

- jet automatic hand dryers
- air is flowing as long as hands are in the active range
- adjustable drying time 3 - 33 s, standard 20 s
- water drains to the tank placed in the bottom part of the dryer, no floor pollution by water under the dryer

Dimension

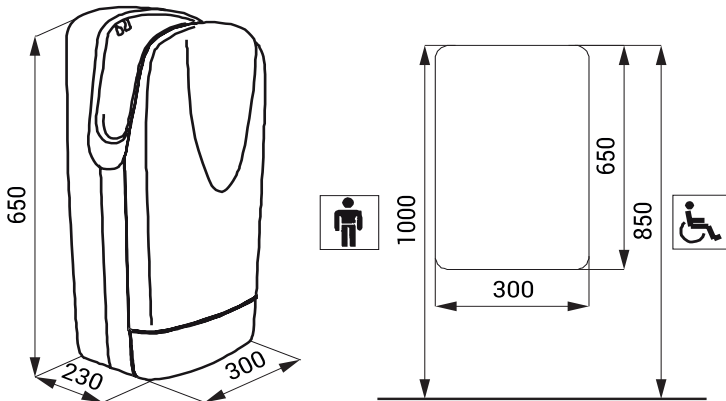

Technical Specification

Dimension	650 x 300 x 230 mm
Operating voltage	230 V/50 Hz
Power input	2000 W
Air flow	300 km/h
Protection	class II, IP 31
Weight	9,5 kg
Noise level	< 90 dB

Supply Specification

SLO 01L - Supply No. 79011	automatic hand dryer, white plastic cover
SLO 01S - Supply No. 79012	automatic hand dryer, grey plastic cover